

Redox chemistry of H₂S oxidation by the British Gas Stretford Process

Part. II: Electrochemical behaviour of aqueous hydrosulphide (HS⁻) solutions

G. H. KELSALL, I. THOMPSON*

Department of Mineral Resources Engineering, Imperial College, London SW7 2BP, Great Britain

Received 30 January 1991; revised 31 July 1992

Electrochemical techniques were used to study the oxidation of HS⁻ ions at pH 9.3. Voltammetry of gold electrodes in HS⁻-containing solutions showed that multilayers of sulphur and soluble oxidation products were formed. As a known HS⁻ oxidation product, thiosulphate solutions were also studied voltammetrically, but found to be electro-inactive at mildly oxidising potentials. The voltammetric behaviour of polysulphide ions, S_n²⁻ (*n* = 2 to 5), was similar to that of HS⁻ solutions on oxidation, though they could be reduced to HS⁻ ions at low potentials. Ring-disc electrode experiments, extending the HS⁻ concentration range that had been studied previously, confirmed that polysulphide ions were produced on reduction of anodically deposited elemental sulphur. This was demonstrated in both cyclic voltammetry and potential step experiments. By comparison of the charges passed producing polysulphides from sulphur and reducing them to HS⁻ ions, an average polysulphide chain length of 1.8 was calculated, indicating a mixture of species was produced. Ion chromatography confirmed that polysulphide solutions do contain a number of species, consistent with thermodynamic predictions.

1. Introduction

The British Gas Stretford Process for the removal of H₂S from natural and process gases has been described elsewhere [1–3], as have the thermodynamics of sulphur–water systems [4]. The objective of the presently reported work was to investigate the electrochemical kinetics and mechanisms of the S/HS⁻ couple under conditions relevant to the Stretford Process, in which the homogeneous oxidation of HS⁻ ions:

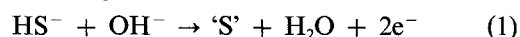

is driven by the reduction, ultimately of dissolved oxygen, mediated by anthraquinone disulphonates (AQDS) [5] and V(V) species [6], the electrochemical behaviour of which is reported elsewhere. The behaviour of the coupled redox reactions AQDS/HS⁻, AQDSH⁻/O₂ and V(V)/HS⁻ was also studied [7] using primarily stopped flow spectrophotometry.

2. Experimental details

2.1. Electrochemical instrumentation

Electrochemical investigations of hydrosulphide ions in aqueous solution are complicated by the propensity of metals to interact strongly with sulphur species; this is less of a problem with gold than platinum [8], though even gold can dissolve in sulphide solutions to

form the gold (I) complex AuS⁻ [9] which is thermodynamically stable in alkaline solution. Recent evidence [10–13] suggested that gold electrodes at potentials > -0.5 V vs SHE in sulphide solutions at pH 9.2, became coated with a gold sulphide phase, though this did not passivate the electrode towards further sulphur deposition. Hence, the oxidation kinetics of hydrosulphide and polysulphide solutions were studied using voltammetry at a gold rotating ring-disc electrode (RRDE) system (Oxford Electrodes). The disc area was 0.3848 cm² and the electrode dimensions were *r*₁ = 3.5, *r*₂ = 3.75, *r*₃ = 4.0 mm, which corresponds to a theoretical current collection efficiency of 0.17 [14], as verified experimentally with ferri/ferrocyanide.

The ring-disc electrode was polished to a mirror finish with 0.3 μm alumina powder. Cathodic polarization and potential cycling were investigated as possible methods of electrode activation. Holding the electrode at -1.7 V vs SHE removed the adsorbed oxygen, but subsequent voltammograms recorded in sulphide solutions showed current densities lower than those which were obtained after the electrode had undergone potential cycling, suggesting the presence of adsorbed sulphur. It was found that potential cycling at 10 V s⁻¹ between -1.25 V and +1.75 V vs SHE produced an active gold surface. If the anodic limit of the potential scans was decreased to -0.2 V vs SHE,

* Present address: Lever Development Centre Casalpusterlengo, via Lever Gibbs, 20071 Casalpusterlengo, Italy.

the electrode surface was not activated; adsorbed sulphur on the gold electrode is oxidized to sulphate only at potential > 0.5 V vs SHE [10]. After potential cycling, the electrode was held at the cathodic limit, prior to a potential scan or pulse.

Current densities were calculated from the geometrical surface area unless otherwise stated. The real surface area of the gold disc electrode was determined by sweeping the potential from 0.5 to 1.7 V vs SHE at 10 mVs^{-1} and integrating the gold oxide formation current in $1 \text{ kmol HClO}_4 \text{ m}^{-3}$ [15]. The formation of one monolayer of oxide on polycrystalline gold with a roughness factor of one requires 0.40 mC cm^{-2} ; hence, the surface roughness factor of the polished gold disc electrode was found to be 1.3.

The ring-disc electrode potentials were controlled using a laboratory-built bipotentiostat, with programming potentials provided by two Hi-Tek PPR1 waveform generators. The ring and disc currents were recorded on JJ Loyd PL4 $xy-t$ chart recorders.

2.2. Electrolyte preparation

Carbonate and borate buffer solutions of pH 9.3 and 9.2, were prepared respectively, from (i) $0.059 \text{ kmol Na}_2\text{CO}_3 + 0.223 \text{ kmol NaHCO}_3 + 0.10 \text{ kmol Na}_2\text{SO}_4 \text{ m}^{-3}$ and (ii) $12.5 \text{ mol Na}_2\text{B}_4\text{O}_7 \cdot 10\text{H}_2\text{O} + 0.9 \text{ mol NaOH} + 0.1 \text{ kmol Na}_2\text{SO}_4 \text{ m}^{-3}$ analytical grade reagents (BDH Merck, Ltd) in triply distilled water. A stock solution containing $0.1 \text{ kmol HS}^- \text{ m}^{-3}$ was prepared from dried crystals of analytical grade sodium sulphide (BDH Merck, Ltd) dissolved in the appropriate deoxygenated buffer solution. The molarity of this stock solution was checked by iodate titration [16], since even solid sodium sulphide is oxidised by atmospheric oxygen and is deliquescent. Freshly opened sodium sulphide was found to contain about 32% Na_2S , corresponding to 9.23 moles of water of crystallisation. Stock sulphide solutions could be kept for several weeks without degradation in a septum-stoppered bottle with a nitrogen atmosphere over the liquid.

Sodium tetrasulphide (Na_2S_4) was prepared by the method of Schwarzenbach and Fischer [17]. Polysulphide solutions were prepared by either dissolving the appropriate mass of Na_2S_4 in an oxygen-free buffer solution, or by dissolving elemental sulphur in sulphide solution. A stock solution with an average polysulphide chain length two, was prepared by adding elemental sulphur to a solution of Na_2S in the molar ratio 1:1.

2.3. Ion chromatography

The experimental apparatus was configured as shown in Fig. 1. A glass reservoir held the $0.1 \text{ kmol Na}_2\text{CO}_3 \text{ m}^{-3}$ eluent, which was sparged constantly with nitrogen and pumped (Kontron 414T) at 3.8 MPa through a pressure damper and (0.02 cm^3) injection port into a Dionex AG3 guard column. The latter prevented strongly adsorbing ions from poisoning the main ion exchange column. Both a LKB 2238 Unicord SII fixed

wavelength u.v. detector (at 254 nm) and a Dionex ECD electrochemical detector were used. The latter consisted of a silver working electrode (held at -0.1 V against a Ag/AgCl reference electrode) and a gold counter electrode; any sulphide or polysulphide produced an oxidation current due to Ag_2S formation:

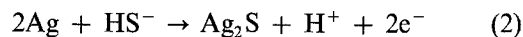

Aqueous polysulphide solutions were prepared by diluting stock solutions with deoxygenated purified water to form solutions in the concentration range $0.1\text{--}1.0 \text{ mol m}^{-3}$.

The concentrations of polysulphide ions in the injected samples were calculated from the rate constants for the equilibration between the various species [18]. From the initial concentrations of S(0) and S(−II), and knowing the pH, the equilibrium concentrations of the polysulphide species were calculated. The program TKSOLVER run on a Digital 350 micro-computer was used to solve numerically the resulting set of simultaneous equations. Corrections were made for the effect of ionic strength by calculating the activity coefficients [19].

3. Results and discussion

3.1. Voltammetry of aqueous hydrosulphide solutions

Figure 2 shows a voltammogram of a gold electrode in sulphide solution at pH 9.2. The main oxidation peak at $+0.09$ V vs SHE was due to the oxidation HS^- ions producing layers of elemental sulphur, the dielectric nature of which inhibited further oxidation. On the negative-going potential scan, the corresponding reduction was observed at potentials < -0.43 V vs SHE, the large potential separation of current peaks indicating a highly irreversible process. The integrated charge under the oxidation peak was approximately 20 C m^{-2} (based on the real surface area), whereas a monolayer of sulphur requiring $2F \text{ mol}^{-1}$, has been calculated to correspond to charge densities of 3.5 and 2.3 C m^{-2} [10, 20] (depending on the assumptions made about the sulphur packing), so that several monolayers of sulphur were formed, in agreement with previous reports [10–13, 21].

More oxidation charge was passed than was recovered on the reduction, due to the following:

- (i) A reaction that produced soluble sulphur oxidation products occurred in parallel with that of sulphur formation. Possible alternative oxidation products include polysulphides, thiosulphate, sulphite and sulphate, according to thermodynamic predictions [4].
- (ii) The sulphur layer was reduced to form polysulphide rather than hydrosulphide ions. Polysulphide ions could diffuse into the solution before they were further reduced.

Sulphate production in the positive-going potential scan and polysulphide production in both the positive and negative-going scans, have been suggested as the reasons for the charge imbalance [10].

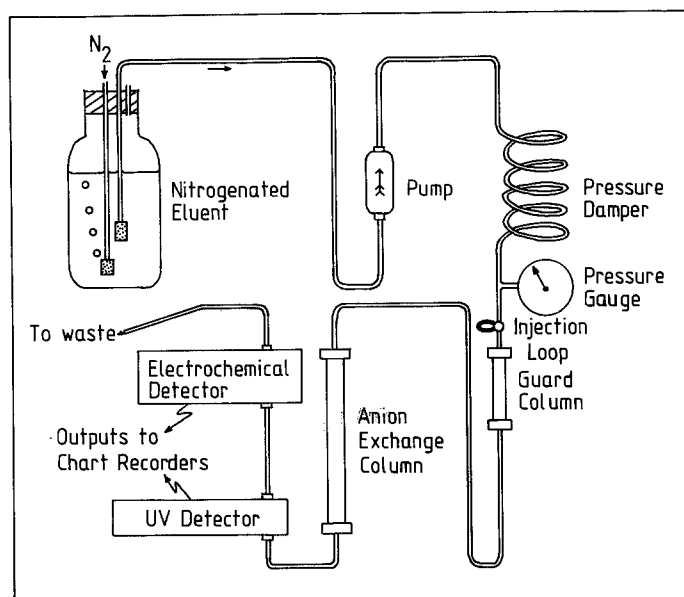
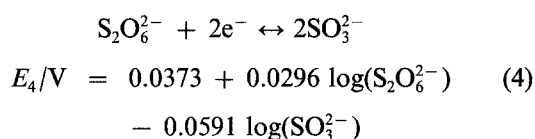
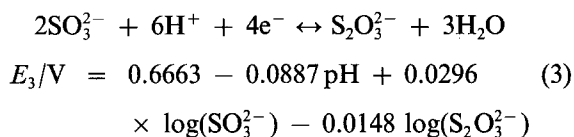

Fig. 1. Ion chromatography apparatus.

3.2. Thiosulphate voltammetry

Thiosulphate is known to be a metastable oxidation product from sulphide oxidation [22, 23]. Thermodynamic calculations for the metastable sulphur-water system [4] predict that at pH > 7.2, thiosulphate can be oxidised to HSO₃⁻, then S₂O₆²⁻ ions and ultimately to the stable product, SO₄²⁻ ions:



Thiosulphate ions are also predicted to be capable of

reduction to hydrosulphide ions:

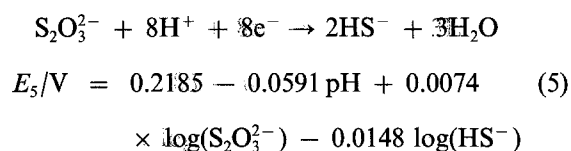

Hence, the electrochemical behaviour of thiosulphate ions at a gold electrode was investigated to determine whether their reduction occurred in the potential range required for polysulphide ion reduction in a ring-disc electrode experiment.

A gold disc electrode was cycled between the potential limits -0.75 and 0.3 V vs SHE in a solution containing 10 mol Na₂S₂O₃ m⁻³ at pH 8.2; no reduction currents were observed in addition to those obtained with the buffer solution alone. If the potential range was increased, voltammograms such as those shown in Fig. 3 were observed. In the negative-going

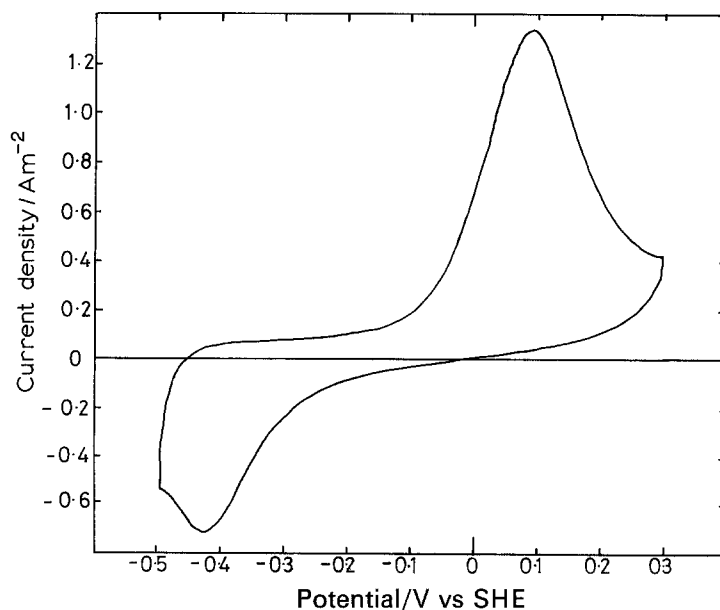
 Fig. 2. Voltammogram of a gold-plated disc electrode in a borate buffer containing 10 mol HS⁻ m⁻³, *n*th cycle; 20 mV s⁻¹.

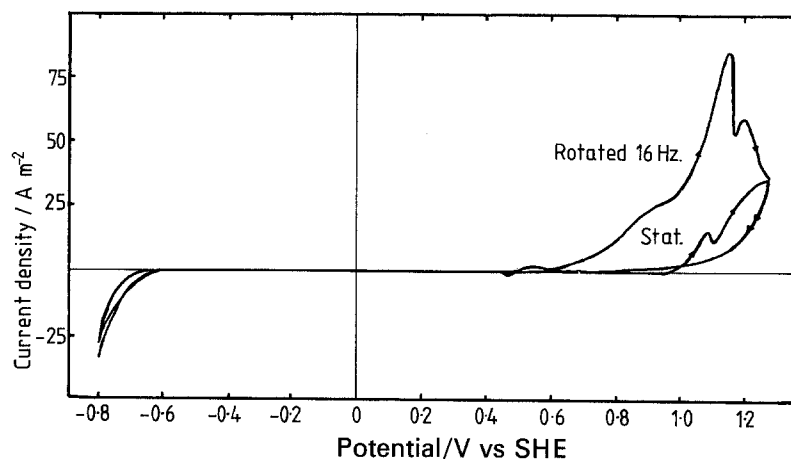

Fig. 3. Cyclic voltammogram of a gold electrode in 10 mol $\text{Na}_2\text{S}_2\text{O}_3 \text{ m}^{-3}$ at pH 8.2. First scan at 100 mV s^{-1} .

scan, no reduction currents were observed until hydrogen was evolved at a potential of -0.7 V vs SHE. In the positive-going scan, an oxidation peak at 0.6 V vs SHE was due to the formation of gold oxide. At higher potentials, 1.1 and 1.25 V vs SHE, further oxidation peaks were seen, though their magnitudes were approximately an order of magnitude lower than the diffusion limited current calculated from the Levich equation, even assuming only a one electron oxidation (Reaction 3).

It has been claimed that thiosulphate oxidation proceeds via a chemical reaction with hydrogen peroxide, formed anodically at suitably high potentials [22].

3.3. Voltammetry of polysulphide solutions

Potential scans were started from the negative potential limit, or the electrode rest potential (-0.17 V vs SHE); similar results (Fig. 4) were obtained in both cases.

Aqueous polysulphide solutions always contain a proportion of free HS^- ions [4], and so voltammograms of polysulphide and hydrosulphide solutions are very similar. Commencing at -0.8 V vs SHE, the first positive-going scan showed an oxidation pre-wave at around -0.5 V vs SHE, with a corresponding inte-

grated charge density (based on the real surface area) of 0.5 C m^{-2} , which corresponds to the discharge of about 0.2 monolayers of sulphur. Similar peaks have been reported previously in the voltammetry of dilute hydrosulphide solutions [10–13] and were attributed to the formation of a gold sulphide phase at the electrode surface:

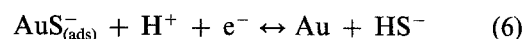

This oxidation peak disappeared after prolonged potential cycling provided the positive limit was kept below 0.5 V , under which conditions an adsorbed sulphur layer is likely to have been present. Increasing the HS^- concentration had the effect of decreasing the potential at which the phase formed, explaining why this oxidation peak appeared only as a shoulder on the hydrogen evolution current in concentrated HS^- solutions (the adsorbed layer is thought to catalyse hydrogen evolution [13]).

The main oxidation peak, which was due to the formation of multilayers of elemental sulphur, was observed at 0.05 V vs SHE. When the electrode was rotated, this had little effect on the peak current density at 1.04 A m^{-2} , which was lower than the diffusion-limited value of 6.5 A m^{-2} . Moreover, the current decreased as the potential was increased above 0.1 V vs SHE, consistent with sulphur passivation of the electrode surface. However, the slight increase in the oxidation peak current on rotation indicated that soluble oxidation products were also produced. In the negative-going potential scan at a stationary electrode, the reduction currents at -0.5 V vs SHE consisted of two waves, due to the reduction of multilayers of sulphur (at -0.4 V vs SHE) and the gold sulphide layer (at about -0.5 V vs SHE).

Figure 4 shows that the reduction of the polysulphide solutions at a rotated electrode resulted in an increased reduction current below -0.4 V . However, no clear diffusion-limited plateau was seen in either the positive or negative-going potential scans. The steady state diffusion-limited current density calculated from the Levich equation, assuming a diffusion coefficient of $5.2 \times 10^{-10} \text{ m}^2 \text{ s}^{-1}$ [11] and a rotation speed of 20 Hz , is 4.2 A m^{-2} for a one electron

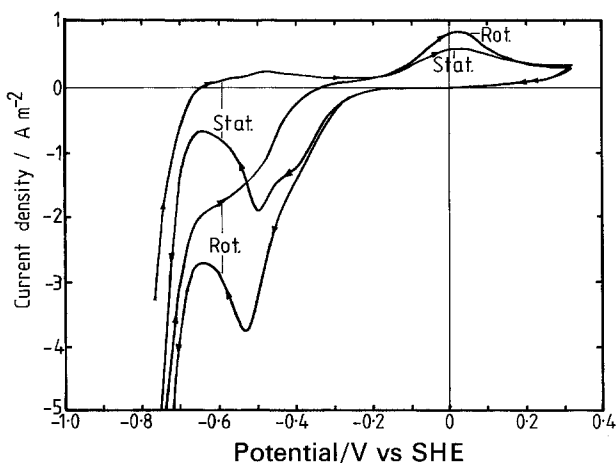

Fig. 4. Voltammograms of polysulphide solution at a gold disc electrode. $1 \text{ mol S}_x^{2-} \text{ m}^{-3}$, $x_{\text{av}} = 2$; pH 8.2; potential scan rate 50 mV s^{-1} .

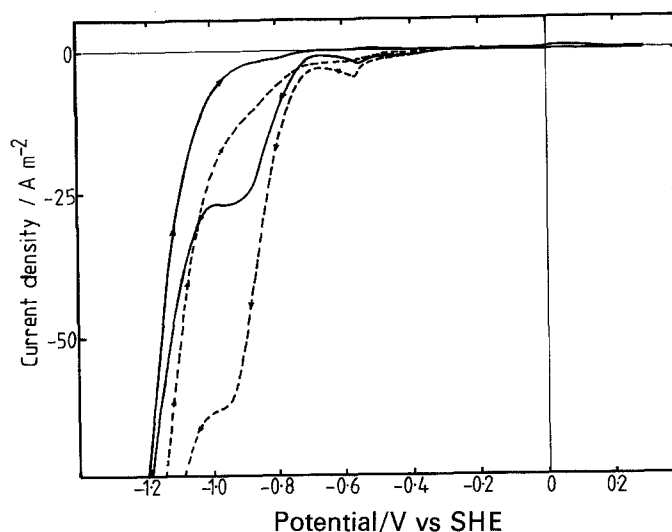
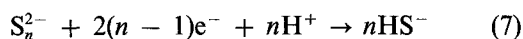

Fig. 5. Voltammograms of polysulphide solution at a gold disc electrode. $1 \text{ mol S}_x^{2-} \text{ m}^{-3}$, $x_{\text{av}} = 2$; pH 8.2; potential scan rate 50 mV s^{-1} . (—) Static; (---) rotating: 20 Hz.

transfer reaction, whereas the current density at -0.6 V vs SHE was only 1.8 A m^{-2} .

If the lower potential limit was decreased, voltammograms such as Fig. 5 were obtained. The current plateau at a potential of -0.95 V vs SHE may have been due to the diffusion-limited reduction of polysulphide ions:



However, the observed current density of 65 A m^{-2} was too high to be attributed solely to this reaction, since the calculated diffusion-limited value is 8.4 A m^{-2} for the complete reduction of all polysulphide species. Thus, the major proportion of the observed reduction current at -0.95 V vs SHE was probably due to hydrogen evolution ($E_{\text{H}_2/\text{H}^+} = -0.48 \text{ V vs SHE}$ at pH 8.2); adsorbed sulphur is known to have a dramatic effect on the hydrogen overpotential [13, 24]. Rotating the electrode increased the hydrogen evolution current, probably by dispersing adhering bubbles. The formation of bubbles could enhance the mass transport rates to the disc electrode provided its effective area was not significantly decreased by adhering bubbles, but would probably decrease the effective collection efficiency of a ring electrode, as has been found for double ring electrodes [25].

At a potential of -0.6 V vs SHE , the polysulphide species may not be reduced completely. A lower potential of about -0.95 V produced a substantial hydrogen evolution current, which may be modified by the local HS^- and H^+ concentrations. Buckley *et al.* [11] showed a clearly defined current plateau at -0.6 V vs SHE (at pH 9.2), and claimed that the magnitude of this reduction current was consistent with the complete reduction of all the polysulphide species. Nevertheless, they chose a substantially more negative potential in order to detect polysulphides at a gold ring: -0.92 V vs SHE (unless they erroneously quoted the potential against SCE rather than against SHE). At this potential a substantial hydrogen evolu-

tion current is likely, and their assumption that this background current is constant (irrespective of surface sulphide concentration and pH changes) is questionable.

A ring potential of -0.75 V vs SHE was chosen for detection of polysulphides from the disc of the rotating ring disc electrode (RRDE), though the electrochemical activity of the ring electrode (even when held at -0.75 V vs SHE) decayed with time. The experiment was conducted after the initial decline in activity had stabilised, and periodically the electrode could be reactivated by potential cycling. Buckley *et al.* [11] noted a similar problem, and reactivated the electrode by pulsing to a highly positive potential. This deactivation suggests that sulphur was still adsorbing onto the electrode surface, even at these low potentials, implying that the polysulphides may not be reduced under mass transport control at the ring electrode. Figure 6 shows the ring and disc currents in response to the disc potential was swept from -0.75 to 0.3 V vs SHE .

At the disc electrode, a small oxidation peak due to gold sulphide formation at -0.53 V vs SHE was seen in the positive-going scan, and the major oxidation peak was seen at 0.065 V vs SHE , as found previously (Fig. 2). The integrated charge under this latter peak was 358 mC , which corresponds to 2–3 monolayers of sulphur. At the ring electrode, little response was observed to the positive-going disc electrode potential scan; the reduction current increased slightly, reaching a maximum value of -2 mA . Assuming that this was due to polysulphide reduction (Reaction 6), and that the polysulphide ions were produced at the disc, the corresponding disc oxidation current would be 11.8 mA , which represents only about 5% of the peak oxidation current at the disc, and supports the hypothesis that polysulphides are oxidized rapidly at a gold electrode to form elemental sulphur [11].

On the negative-going sweep, an increasing disc electrode reduction current was recorded at potentials $< -0.3 \text{ V vs SHE}$. After subtraction of the hydrogen

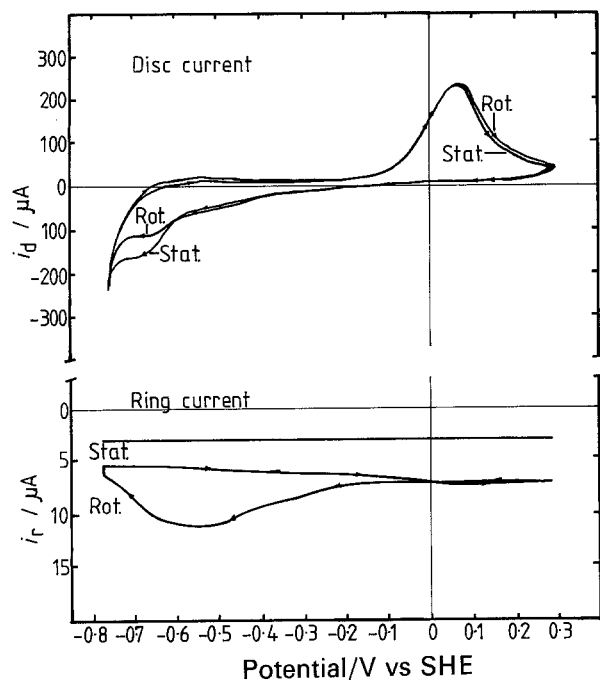
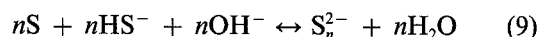
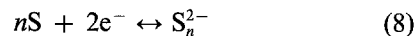

Fig. 6. Gold ring-disc electrode voltammetry of $10 \text{ mol HS}^- \text{ m}^{-3}$ at pH 9.3, $\omega = 9 \text{ Hz}$; potential scan rate 100 mV s^{-1} ; ring potential = -0.75 V vs SHE .

evolution charge, the integrated charge passed in the negative-going scan was 200 mC . This included a component which is due to the reduction of the gold sulphide surface phase for which Buckley *et al.* [11] quoted a value of 0.9 C m^{-2} , corresponding to 45 mC on the experimental surface area. Therefore, the charge passed in reducing the multilayer sulphur, Q_d was 155 mC , which was 43% of the charge passed to form the sulphur.

During the negative-going disc electrode potential scan, a ring electrode reduction current was observed to reach a maximum at a disc potential of -0.535 V vs SHE . This current resulted from the reduction of polysulphide ions from the disc; if the electrode was stationary, no reduction currents were observed. There are two possible ways in which these polysulphide ions can be produced: from the electrochemical

reduction of adsorbed sulphur by Reaction 8, or from the chemical dissolution of sulphur in HS^- solutions by Reaction 9.



At a disc potential of -0.15 V vs SHE , no current flowed at the disc, yet an increased reduction current of about 2 mA was observed. This must have been due to the production of polysulphide ions by chemical dissolution of the sulphur layers by Reaction 9. An estimate of the current due to polysulphide production due to the electrochemical reduction of sulphur can be gained by subtracting this 2 mA from the ring reduction currents observed at a lower disc potential. The integrated charge (Q_r) due to the reduction of electrochemically-produced polysulphide, was found to be 21.2 mC .

If it is assumed that:

- (i) all the sulphur was reduced at the disc electrode to form polysulphide ions by Reaction 8,
- (ii) polysulphide ions reaching the ring electrode were fully reduced to HS^- ions by Reaction 7, then the ratio of the two charges will be given by:

$$NQ_d/Q_r = (n - 1)^{-1} \quad (10)$$

where N is the ring collection efficiency. The average polysulphide chain length (n), calculated from Equation 10 for $Q_d = 155 \text{ mC}$, $Q_r = 21.2 \text{ mC}$ and $N = 0.17$, is $n = 1.8$.

In a similar analysis, Buckley *et al.* [11] calculated that the polysulphide had $n = 3.3$ at the lower concentration of $0.2 \text{ mol HS}^- \text{ m}^{-3}$ at pH 9.2. It can be concluded that in both cases the reduction product is likely to contain a mixture of polysulphide species. This is not unexpected, since different polysulphide species are predicted to predominate as the potential range was scanned (Fig. 4a in [4]).

The reduction of the sulphur layers was found to correspond to 155 mC , and if this resulted in the formation of a polysulphide of average stoichiometry $\text{S}_{1.8}^{2-}$,

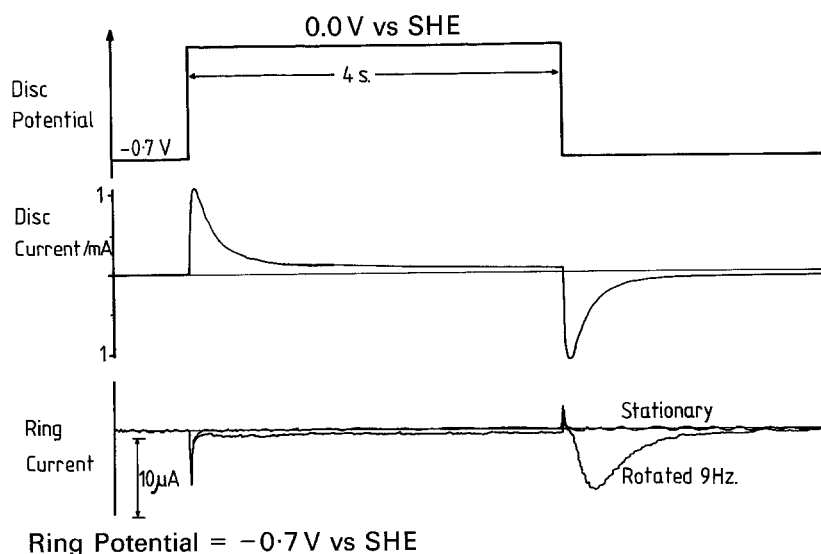

Fig. 7. Gold ring-disc electrode potential pulse response in $10 \text{ mol HS}^- \text{ m}^{-3}$ at pH 9.3; $\omega = 9 \text{ Hz}$.

the sulphur must have been deposited with the passage of 279 mC. For $E < E_{S/S_2^{2-}}$, previously deposited sulphur could also have dissolved chemically to form more polysulphide ions. Over the time span of the deposition of the sulphur (about 8 s) a reduction current at the ring of 2 mA was observed due to the reduction of these polysulphide ions. Thus, at the ring electrode a further charge of 16 mC was passed. Assuming a collection efficiency of 0.17, the amount of sulphur dissolved would have required the passage of $16/0.17 = 94$ mC for its production at the disc. Thus, in total, $279 + 94 = 373$ mC would be expected to have been passed on the anodic scan, which is in approximate agreement with the observed anodic charge of 358 mC. Therefore, the charge imbalance at the disc can be attributed to the production of polysulphides in both the positive- and negative-going scans; little or no sulphy species must have been formed.

In the above analysis, it is strictly legitimate to use ring and disc charges, rather than currents, only when the collection efficiency and the composition of the intermediate species remain constant as the disc potential is scanned. A constant collection efficiency requires that the reduction of polysulphide ions at the ring always operates under mass transport control, irrespective of the polysulphide flux over the ring. The nature of the polysulphide ions that are produced from sulphur reduction are likely to vary with potential, and so the above calculations will only lead to an average value for the chain length of the polysulphide. Results from potential step experiments at the RRDE can provide a more accurate estimate of the polysulphide produced at a particular reduction potential.

Potential step experiments also confirmed that polysulphides were produced during the formation and reduction of elemental sulphur. The experiments were conducted in deoxygenated solutions containing $10 \text{ mol HS}^- \text{ m}^{-3}$ at pH 9.3. The ring potential was maintained at -0.7 V vs SHE throughout, and the disc potential was stepped from this to a more positive value for 4 s, and then stepped back to -0.7 V vs SHE . The experiment was repeated, with and without electrode rotation, for different values of the disc potential step. The resulting current response is shown in Fig. 7.

The potential step to 0.0 V vs SHE was sufficient to form multilayers of elemental sulphur, and a small reduction current resulted at the ring due to the detection of polysulphides. When the potential was pulsed back to -0.7 V vs SHE , the sulphur at the disc was reduced, and an increased reduction current was observed at the ring. The ratio of ring to disc currents were lower than those expected for the production of a polysulphide on average chain length 1.8. This suggested either that less polysulphide was produced (a calculation of the average chain length gave $n = 1.1$) or that the ring electrode had become deactivated. The ratio of i_r to i_d rose rapidly in the first 250 ms following the potential pulse, thereafter remaining approximately constant at about 0.025.

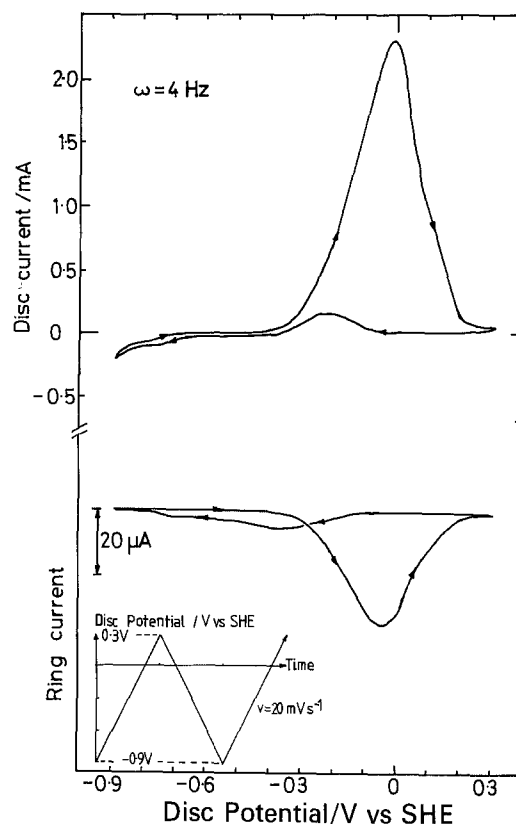

Fig. 8. Gold ring-disc electrode voltammetry in $1 \text{ kmol HS}^- + 1 \text{ kmol NaOH m}^{-3}$; $\omega = 4 \text{ Hz}$, n th scan; potential scan rate 20 mV s^{-1} ; ring potential = -0.90 V vs SHE .

The reduction of the sulphur layers when the potential was pulsed to -0.7 V vs SHE , resulted in the production of a smaller proportion of polysulphide ions than was observed in the potential sweep experiments. However, the nucleation and growth of the sulphur will differ in the two cases. The decoupling of the faradaic and non-faradaic components of a disc electrode current by analysis of the time-dependence of the ring electrode response, has been reported [26], but was not attempted in this more complex system.

If the disc potential was stepped to potentials below that at which multilayers of sulphur can form, i.e., no more positive than -0.1 V vs SHE , no current response was seen at the ring electrode. When the disc potential was stepped to 0.1 and 0.2 V vs SHE, higher ring currents were seen while the disc was held at these potentials, indicating that higher concentrations of polysulphides were formed.

In a highly alkaline concentrated solution of HS^- ions, the chemical dissolution of sulphur by Reaction 9 is favoured. A ring-disc electrode response in a solution of $1 \text{ kmol Na}_2\text{S} \cdot 9\text{H}_2\text{O} + 1 \text{ kmol NaOH m}^{-3}$ showed that the polysulphide species could be detected in the positive-going scan, as shown in Fig. 8. Although a polysulphide reduction current was still detected on the negative-going (disc potential) scan, the largest current was seen during the positive-going scan. On relaxing the anode potential to $< E_{S/S_2^{2-}}$, previously deposited sulphur was dissolved by the high concentrations of HS^- ions flowing over the electrode surface, giving rise to an increasing net oxidation current

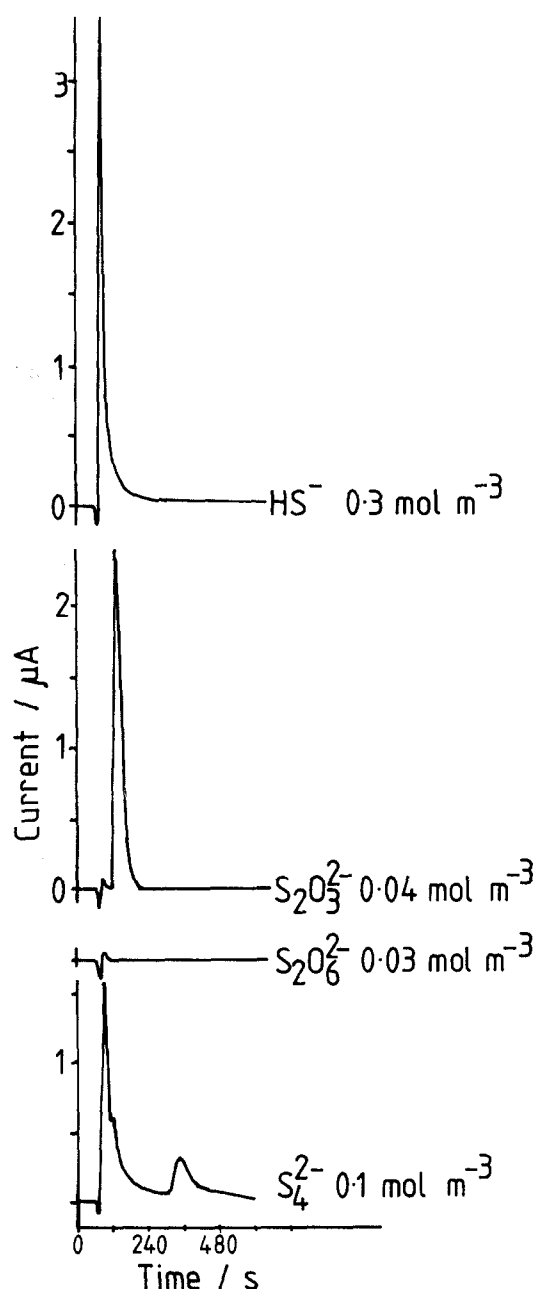

Fig. 9. Ion chromatogram of polysulphide solution, pH9.2.

with decreasing potential and producing polysulphide ions which were reduced at the ring electrode.

3.4. Detection of polysulphides using ion chromatography

The feasibility was investigated of detecting polysulphide ions using ion chromatography, since although they absorb in the u.v.-visible spectral range, spectrophotometry cannot be used routinely, as other components of a Stretford Process solutions absorb in the same spectral region.

The polysulphide activity-potential diagram for pH9.2 (Fig. 4a in [4]) showed that only three solution species, S_4^{2-} , S_5^{2-} and HS^- ions, were important in polysulphide mixtures. An injection of polysulphide solution resulted in the detection of three peaks, as shown in Fig. 9. The peak heights of the second and third peaks (those two peaks having the longest retention times) correlated well with the calculated concen-

trations of S_4^{2-} and S_5^{2-} ions. However, the response of the first peak, which was assigned to the HS^- ion, was larger than expected. This suggested that disproportionation occurred as the sample traversed the column.

4. Conclusions

Oxidation of HS^- ions at pH9.3 has been shown to produce a sub-monolayer of adsorbed sulphur on a gold electrode at low potentials (-0.4 V vs SHE), and multilayers of sulphur at higher potentials (0.05 V vs SHE). Associated with the formation of elemental sulphur is the production of polysulphide anions, S_n^{2-} ($n = 2$ to 5), which can also be produced by the dissolution of the initial sulphur layer. The production of such polysulphide species accounted for the difference in charge between the positive and negative-going scans, without the need to invoke the anodic formation of sulphony species.

On reduction of the sulphur layers, polysulphide ions were produced, which were detected at the ring of a rotating ring-disc electrode. By a comparison of the charges passed in the production of these ions from elemental sulphur, and their reduction to HS^- ions, an estimate of the average polysulphide chain length was calculated to be 1.8, indicating that a mixture of polysulphides was produced. This is consistent with thermodynamic predictions which show that a number of polysulphides can exist in solution at comparable concentrations at any given potential.

Ion chromatography was investigated as a means of detecting polysulphide ions in solution, but disproportionation of the polysulphide species as they traverse the ion exchange column and the air-sensitive nature of the solutions made the method unsuitable for routine use.

Acknowledgements

The authors thank the UK Science and Engineering Research Council (SERC) and British Gas for the provision of a CASE research studentship for Ian Thompson.

References

- [1] B. M. Wilson and R. D. Newell, *Chem. Eng. Prog.* **80**(10), (1984) 40.
- [2] G. H. Kelsall and I. Thompson, in Proc. Gas Research Institute (GRI) Symposium on 'Liquid Redox Processes for Hydrogen Sulphide Removal', Austin TX, May, 1989, GRI, Chicago, (1989) pp. 34-50.
- [3] I. Thompson, Ph.D. Thesis, University of London (1987).
- [4] G. H. Kelsall and I. Thompson, *J. Appl. Electrochem.* **23** (1993) 279.
- [5] *Idem*, *J. Appl. Electrochem.* **23** (1993) 296.
- [6] G. H. Kelsall, I. Thompson and P. A. Francis, *J. Appl. Electrochem.* **23** (1993) in press.
- [7] G. H. Kelsall and I. Thompson, *J. Appl. Electrochem.* **23** (1993) in press.
- [8] S. Kapusta, A. Viehbeck, S. Wilhelm and N. Hackerman, *J. Electroanal. Chem.* **153** (1983) 175.
- [9] R. M. Garrels and C. L. Christ, 'Solutions, Minerals, and Equilibria', Harper and Row, New York (1965), 257-8.
- [10] I. C. Hamilton and R. Woods, *J. Appl. Electrochem.* **13** (1983) 783.

- [11] A. N. Buckley, I. C. Hamilton and R. Woods, *J. Electroanal. Chem.* **216** (1987) 213.
- [12] A. Bricenco and S. Chander, *J. Appl. Electrochem.* **20** (1990) 506, 512.
- [13] R. O. Lezna, N. R. de Tacconi and A. J. Arvia, *J. Electroanal. Chem.* **283** (1990) 319.
- [14] W. J. Albery and M. L. Hitchman, 'Ring-Disc Electrodes', Clarendon Press, Oxford (1971).
- [15] D. Dickertmann, J. W. Schultze and K. J. Vetter, *J. Electroanal. Chem.* **55** (1974) 429.
- [16] G. H. Jeffery, J. Bassett, J. Mendham and R. C. Denney, 'Vogel's Quantitative Chemical Analysis', Longman, Harlow, 5th edn. (1989).
- [17] G. Schwarzenbach and A. Fischer, *Helv. Chim. Acta* **43** (1960) 1365.
- [18] W. Giggenbach, *Inorg. Chem.* **11**(6), (1972) 1201.
- [19] A. Albert and E. Serjeant, 'The Determination of Ionisation Constants: A Laboratory Manual', Chapman Hall, London, 3rd. edn. (1984) p. 218.
- [20] M. R. Goodenough, Ph.D. Thesis, University of London (1987).
- [21] L. M. Huang, J. M. Bauldreay, S. M. Wilhelm, S. D. Kapusta and N. Hackerman, Proc. Int. Symposium: Surfaces, Inhibition, and Passivation, Electrochem. Soc., Pennington NJ, 86-7, (1986) 493-506.
- [22] S. Zhdanov, in 'Encyclopedia of Electrochemistry of the Elements', Vol. IV, Ch. 6: Sulphur, (edited by A. J. Bard) Marcel Dekker, New York (1975) p. 328.
- [23] A. T. Kuhn, G. H. Kelsall and M. S. Chana, *J. Chem. Biotechnol.* **33A** (1983) 406.
- [24] P. Marcus, S. Montes and J. Oudar, *J. Electroanal. Chem.* **119** (1981) 137.
- [25] I. V. Kadija, B. Z. Nikolic and A. R. Despic, *J. Electroanal. Chem.* **57** (1974) 35.
- [26] W. J. Albery, M. G. Boutelle, P. J. Colby and A. R. Hillman, *J. Chem. Soc. Faraday Trans.* **78** (1982) 2757.